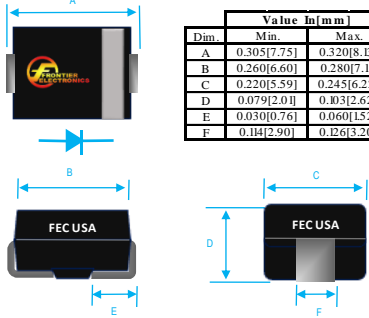

3A ULTRA FAST RECOVERY SURFACE MOUNT RECTIFIER

 <table border="1" style="margin-left: auto; margin-right: auto; border-collapse: collapse; text-align: center;"> <thead> <tr> <th rowspan="2">Dim</th> <th colspan="2">Value in (mm)</th> </tr> <tr> <th>Min</th> <th>Max</th> </tr> </thead> <tbody> <tr> <td>A</td> <td>0.305[7.75]</td> <td>0.320[8.13]</td> </tr> <tr> <td>B</td> <td>0.260[6.60]</td> <td>0.280[7.11]</td> </tr> <tr> <td>C</td> <td>0.220[5.59]</td> <td>0.245[6.22]</td> </tr> <tr> <td>D</td> <td>0.079[2.01]</td> <td>0.103[2.62]</td> </tr> <tr> <td>E</td> <td>0.030[0.76]</td> <td>0.060[1.52]</td> </tr> <tr> <td>F</td> <td>0.14[2.90]</td> <td>0.126[3.20]</td> </tr> </tbody> </table>	Dim	Value in (mm)		Min	Max	A	0.305[7.75]	0.320[8.13]	B	0.260[6.60]	0.280[7.11]	C	0.220[5.59]	0.245[6.22]	D	0.079[2.01]	0.103[2.62]	E	0.030[0.76]	0.060[1.52]	F	0.14[2.90]	0.126[3.20]	<p>PRODUCT FEATURES</p> <ol style="list-style-type: none"> 1. FLAMMABILITY CLASSIFICATION: 94V-0 2. GLASS PASSIVATED CHIP JUNCTION 3. BUILT-IN STRAIN RELIEF 4. LOW PROFILE 5. ULTRA FAST SWITCHING 6. CASE: MOLDED PLASTIC, DO-214AB (SMC-F) 7. POLARITY: INDICATED BY CATHODE BAND 8. WEIGHT : 0.21 GRAMS 9. TERMINALS : PER MIL-STD-750 METHOD 2026 10. ROHS
Dim		Value in (mm)																						
	Min	Max																						
A	0.305[7.75]	0.320[8.13]																						
B	0.260[6.60]	0.280[7.11]																						
C	0.220[5.59]	0.245[6.22]																						
D	0.079[2.01]	0.103[2.62]																						
E	0.030[0.76]	0.060[1.52]																						
F	0.14[2.90]	0.126[3.20]																						

MAXIMUM RATINGS AND ELECTRICAL CHARACTERISTICS RATINGS AT 25°C AMBIENT TEMPERATURE UNLESS OTHERWISE SPECIFIED STORAGE AND OPERATING TEMPERATURE RANGE -55°C TO + 150°C. SINGLE PHASE, HALF WAVE, 60 HZ, RESISTIVE OR INDUCTIVE LOAD. FOR CAPACITIVE LOAD, DERATE CURRENT BY 20%

RATINGS		SYMBOL	VALUE	UNITS
MAXIMUM AVERAGE FORWARD RECTIFIED CURRENT @ 75°C		IO	3	A
PEAK FWD SURGE CURRENT, 8.3ms HALF SINE-WAVE SUPERIMPOSED ON RATED LOAD		IFSM	100	A
TYPICAL JUNCTION CAPACITANCE(NOTE 1)		CJ	75	pF
TYPICAL THERMAL RESISTANCE (NOTE 2)		Rqja	15	°C/W
MAXIMUM REVERSE CURRENT @ 25°C		IR	10	uA
MAXIMUM REVERSE CURRENT @ 125 °C		IR	250	uA

1. Cj MEASURED @ 1 MHZ AND APPLIED REVERSE VOLTAGE OF 4.0 VOLTS
2. THERMAL RESISTANCE FROM JUNCTION TO AMBIENT AND JUNCTION TO LEAD PCB MOUNTED ON 0.3×0.3"(8.0×8.0mm) COPPER PAD AREAS
3. REVERSE RECOVERY TEST CONDITIONS: IF=0.5A, IR=1.0A, IRR=0.25A
4. MAXIMUM FORWARD VOLTAGE @ Io DC

PART NUMBER	MAX RECURRENT PK REV VOLTAGE VRRM (V)	MAX RMS VOLTAGE VRMS (V)	MAX DC BLOCKING VOLTAGE VDC (V)	MAX FWD VOLTAGE VF (V)	MAX REVERSE RECOVERY TIME nS
US3A	50	35	50	1	50
US3B	100	70	100	1	50
US3D	200	140	200	1	50
US3G	400	280	400	1.3	50
US3J	600	420	600	1.7	75
US3K	800	560	800	1.7	75
US3M	1000	700	1000	1.85	75

RATING AND CHARACTERISTIC CURVES

FIG. 1-TEST CIRCUIT DIAGRAM AND REVERSE RECOVERY TIME CHARACTERISTIC

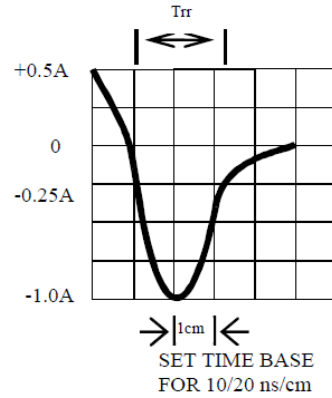
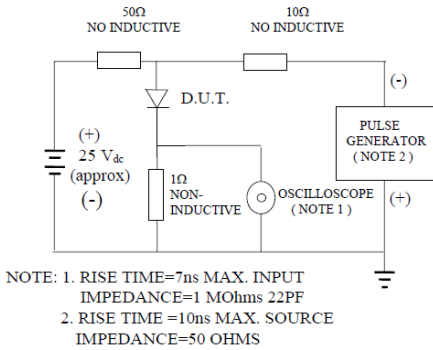

FIG. 2-TYPICAL FORWARD CURRENT DERATING CURVE

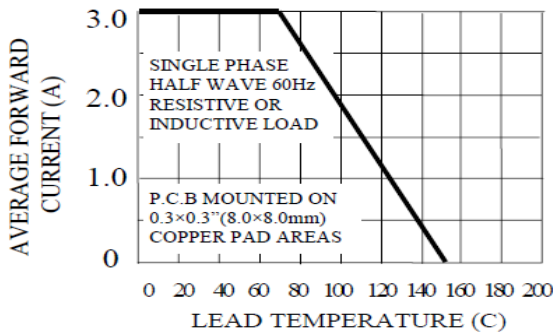

FIG. 3-TYPICAL REVERSE CHARACTERISTICS

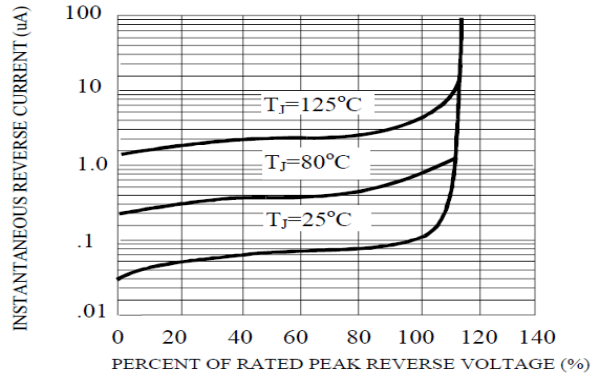

FIG. 4-TYPICAL INSTANTANEOUS FORWARD CHARACTERISTICS

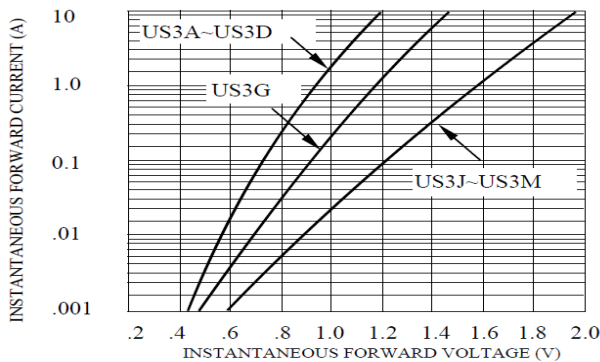
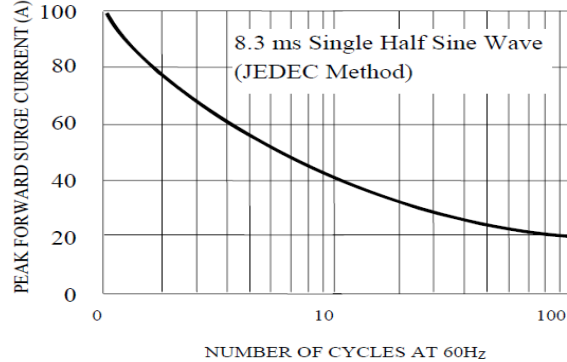

FIG. 5-MAXIMUM NON-REPETITIVE FORWARD SURGE CURRENT





US3A THRU US3M SPECIFICATIONS

Rev. A

