

1.5A FAST RECOVERY GLASS PASSIVATED RECTIFIER

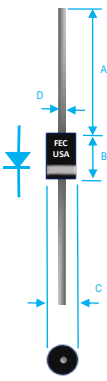

Dim.	Value In (mm)	
	Min.	Max.
A	1.000[25.40]	—
B	0.230[5.84]	0.300[7.62]
C	0.104[2.64]	0.101[3.56]
D	0.028[0.71]	0.034[0.86]

PRODUCT FEATURES

1. FLAMMABILITY CLASSIFICATION: 94V-0
2. GLASS PASSIVATED CHIP JUNCTION
3. HIGH SURGE CURRENT CAPABILITY
4. CASE: TRANSFER MOLDED, DO15
5. DIMENSIONS IN INCHES AND (MILLIMETERS)
6. POLARITY: INDICATED BY CATHODE BAND
7. WEIGHT : 0.34 GRAMS
8. TERMINALS : PER MIL-STD-202, METHOD 208
9. ROHS

MAXIMUM RATINGS AND ELECTRICAL CHARACTERISTICS RATINGS AT 25°C AMBIENT TEMPERATURE UNLESS OTHERWISE SPECIFIED STORAGE AND OPERATING TEMPERATURE RANGE -55°C TO + 150°C. SINGLE PHASE, HALF WAVE, 60 HZ, RESISTIVE OR INDUCTIVE LOAD. FOR CAPACITIVE LOAD, DERATE CURRENT BY 20%

RATINGS	SYMBOL	VALUE	UNITS
MAXIMUM AVERAGE FORWARD RECTIFIED CURRENT 0.375"(9.5mm) LEAD LENGTH @ 55°C	IO	1.5	A
PEAK FWD SURGE CURRENT, 8.3ms HALF SINE-WAVE SUPERIMPOSED ON RATED LOAD	IFSM	50	A
TYPICAL JUNCTION CAPACITANCE(NOTE 1)	CJ	25	pF
TYPICAL THERMAL RESISTANCE (NOTE 2)	Rqjc	40	°C/W
MAXIMUM FORWARD VOLTAGE	VF	1.3	V
MAXIMUM REVERSE CURRENT @ 25°C	IR	5	uA
MAXIMUM REVERSE CURRENT @ 100°C	IR	50	uA

1. MEASURED @ 1.0 MHZ AND APPLIED REVERSE VOLTAGE OF 4.0 V
2. BOTH LEADS ATTACHED TO HEATSINK 20x20x1t(mm) COPPER PLATE AT LEAD LENGTH 5mm
3. REVERSE RECOVERY TEST CONDITIONS: IF=0.5A, IR=1.0A, IRR=0.25A
4. MAXIMUM FORWARD VOLTAGE AT IO DC

PART NUMBER	MAX RECURRENT PK REV VOLTAGE VRRM (V)	MAX RMS VOLTAGE VRMS (V)	MAX DC BLOCKING VOLTAGE VDC (V)	MAX REV RECOVERY TIME TRR (nS)
FR151G	50	35	50	150
FR152G	100	70	100	150
FR153G	200	140	200	150
FR154G	400	280	400	150
FR155G	600	420	600	250
FR156G	800	560	800	500
FR157G	1000	700	1000	500

RATING AND CHARACTERISTIC CURVES

FIG. 1-TEST CIRCUIT DIAGRAM AND REVERSE RECOVERY TIME CHARACTERISTIC

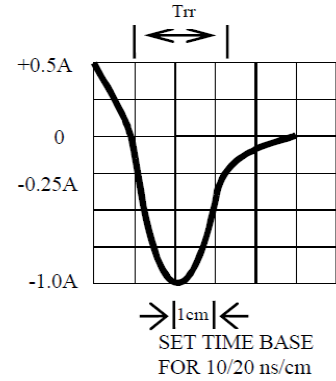
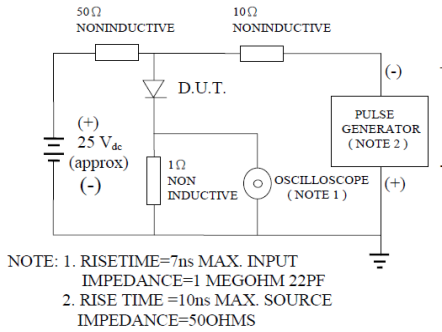

Fig. 2-MAXIMUM CURRENT DERATING CURVE

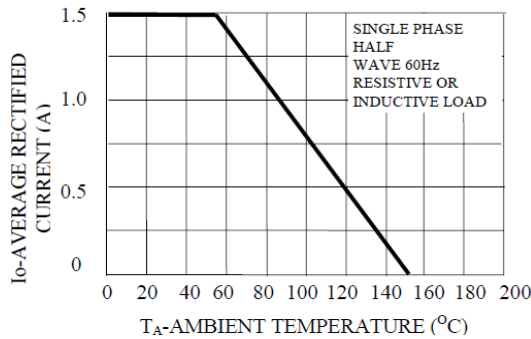

FIG. 3-TYPICAL REVERSE CHARACTERISTICS

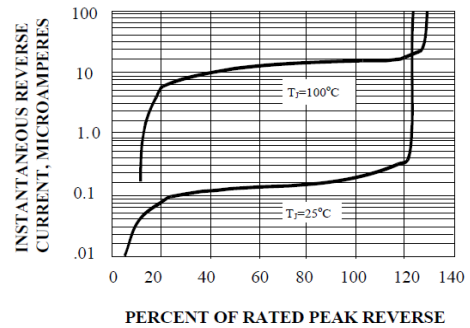

Fig. 4-MAXIMUM FORWARD SURGE NUMBER OF CYCLES

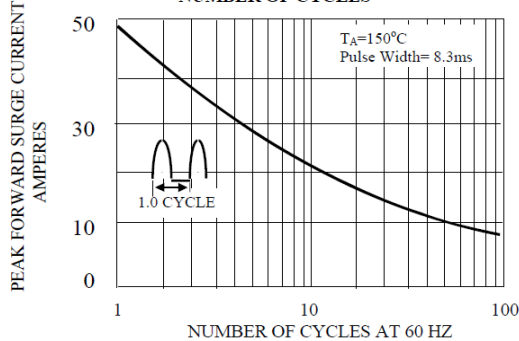
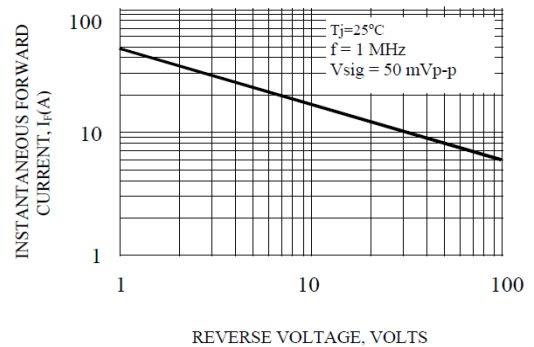

FIG. 5-TYPICAL JUNCTION CAPACITANCE





FR151G THRU FR157G SPECIFICATIONS

Rev. A

