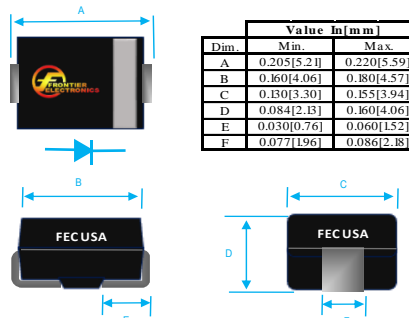

3A SURFACE MOUNT FAST EFFICIENT RECOVERY RECTIFIERS

 <table border="1" style="margin-left: auto; margin-right: auto;"> <thead> <tr> <th rowspan="2">Dim.</th> <th colspan="2">Value in(mm)</th> </tr> <tr> <th>Min.</th> <th>Max.</th> </tr> </thead> <tbody> <tr> <td>A</td> <td>0.205[5.21]</td> <td>0.220[5.59]</td> </tr> <tr> <td>B</td> <td>0.160[4.06]</td> <td>0.180[4.57]</td> </tr> <tr> <td>C</td> <td>0.130[3.30]</td> <td>0.155[3.94]</td> </tr> <tr> <td>D</td> <td>0.084[2.13]</td> <td>0.160[4.06]</td> </tr> <tr> <td>E</td> <td>0.030[0.76]</td> <td>0.060[1.52]</td> </tr> <tr> <td>F</td> <td>0.077[1.96]</td> <td>0.086[2.18]</td> </tr> </tbody> </table>	Dim.	Value in(mm)		Min.	Max.	A	0.205[5.21]	0.220[5.59]	B	0.160[4.06]	0.180[4.57]	C	0.130[3.30]	0.155[3.94]	D	0.084[2.13]	0.160[4.06]	E	0.030[0.76]	0.060[1.52]	F	0.077[1.96]	0.086[2.18]	<h3>PRODUCT FEATURES</h3> <ol style="list-style-type: none"> 1. FLAMMABILITY CLASSIFICATION: 94V-0 2. GLASS PASSIVATED CHIP JUNCTION 3. BUILT-IN STRAIN RELIEF 4. LOW PROFILE 5. CASE: DO-214AA (SMB) MOLDED PLASTIC 6. DIMENSIONS IN INCHES AND (MILLIMETERS) 7. POLARITY: INDICATED BY CATHODE BAND 8. WEIGHT : 0.093 GRAMS 9. TERMINAL: PER MIL-STD-750 METHOD 2026 10. ROHS
Dim.		Value in(mm)																						
	Min.	Max.																						
A	0.205[5.21]	0.220[5.59]																						
B	0.160[4.06]	0.180[4.57]																						
C	0.130[3.30]	0.155[3.94]																						
D	0.084[2.13]	0.160[4.06]																						
E	0.030[0.76]	0.060[1.52]																						
F	0.077[1.96]	0.086[2.18]																						

MAXIMUM RATINGS AND ELECTRICAL CHARACTERISTICS RATINGS AT 25°C AMBIENT TEMPERATURE UNLESS OTHERWISE SPECIFIED STORAGE AND OPERATING TEMPERATURE RANGE -55°C TO + 150°C. SINGLE PHASE, HALF WAVE, 60 HZ, RESISTIVE OR INDUCTIVE LOAD. FOR CAPACITIVE LOAD, DERATE CURRENT BY 20%

RATINGS	SYMBOL	VALUE	UNITS
MAXIMUM AVERAGE FORWARD RECTIFIED CURRENT @ TL=90°C	IO	3	A
PEAK FWD SURGE CURRENT, 8.3ms HALF SINE-WAVE SUPERIMPOSED ON RATED LOAD	IFSM	100	A
TYPICAL JUNCTION CAPACITANCE (NOTE3)	CJ	70	pF
TYPICAL THERMAL RESISTANCE (NOTE 2)	Rqja	12	°C/W
MAXIMUM REVERSE CURRENT @ 25°C	IR	10	uA
MAXIMUM REVERSE CURRENT @ 100°C	IR	200	uA
MAXIMUM REVERSE RECOVERY TIME (NOTE1)	TRR	25	nS

1. REVERSE RECOVERY TIME TEST CONDITION, IF=0.5A, IR=1.0A, IRR=0.25A

2. THERMAL RESISTANCE FROM JUNCTION TO AMBIENT AND JUNCTION TO LEAD P.C.B. MOUNTED ON 0.3×0.3"(8.0×8.0mm) COPPER PAD AREAS

3. MEASURED @ 1 MHZ AND APPLIED REVERSE VOLTAGE OF 4.0 VOLTS

4. MAXIMUM FORWARD VOLTAGE @ IO

PART NUMBER	MAX RECURRENT PK REV VOLTAGE VRRM (V)	MAX RMS VOLTAGE VRMS (V)	MAX DC BLOCKING VOLTAGE VDC (V)	MAX FWD VOLTAGE VF (V)	MARKING
ES3AB	50	35	50	0.98	ES3AB
ES3BB	100	70	100	0.98	ES3BB
ES3DB	200	140	200	0.98	ES3DB
ES3EB	300	210	300	1.3	ES3EB
ES3GB	400	280	400	1.3	ES3GB
ES3JB	600	420	600	1.75	ES3JB

RATING AND CHARACTERISTIC CURVES

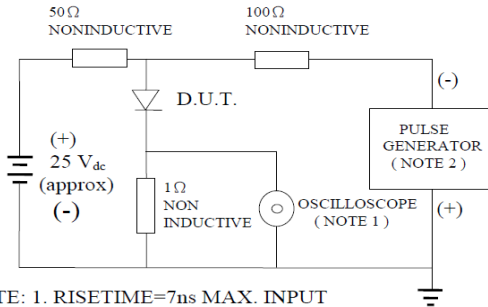

NOTE: 1. RISE TIME = 7ns MAX. INPUT IMPEDANCE = 1 MEGOHM 22PF
 2. RISE TIME = 10ns MAX. SOURCE IMPEDANCE = 50OHMS

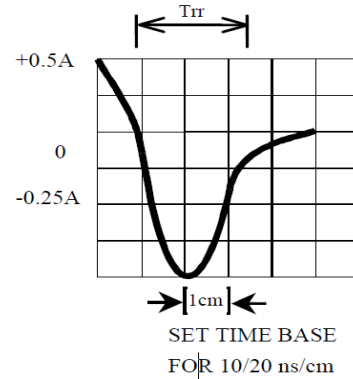

FIG. 2-TYPICAL FORWARD CURRENT DERATING CURVE

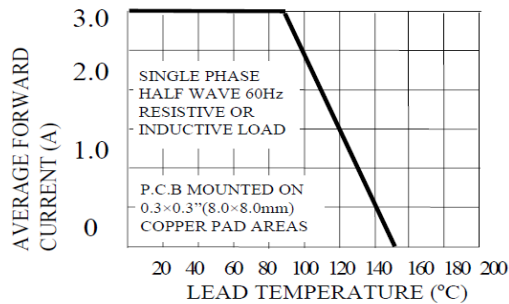

FIG. 3-TYPICAL REVERSE CHARACTERISTICS

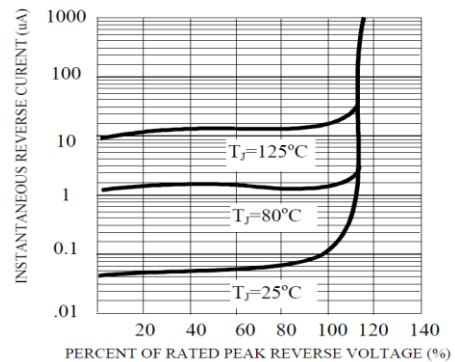

FIG. 4-TYPICAL INSTANTANEOUS FORWARD CHARACTERISTICS

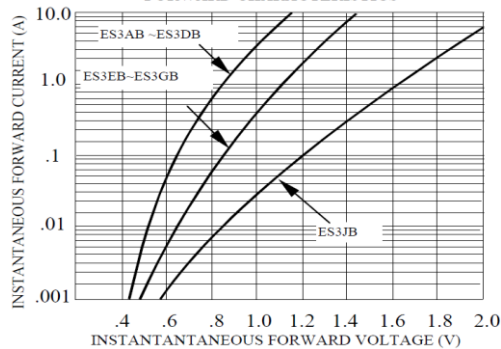
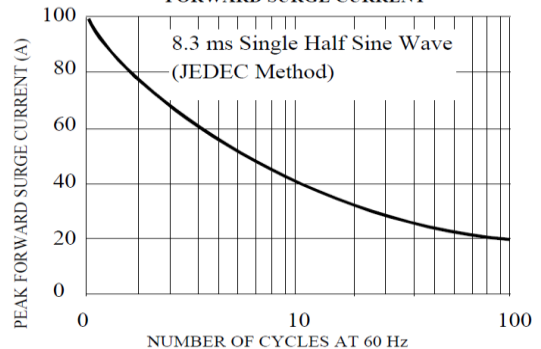

FIG. 5-MAXIMUM NON-REPETITIVE FORWARD SURGE CURRENT





ES3AB THRU ES3JB SPECIFICATIONS

Rev. A

