

1A FAST RECOVERY PLASTIC RECTIFIER

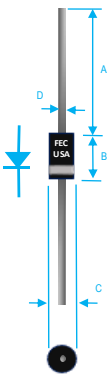

Dim.	Value In(mm)	
	Min.	Max.
A	1.000[25.40]	—
B	0.166[4.23]	0.205[5.21]
C	0.080[2.03]	0.107[2.72]
D	0.021[0.53]	0.025[0.64]

PRODUCT FEATURES

1. FLAMMABILITY CLASSIFICATION: 94V-0
2. 1 A OPERATION @ 55°C WITH NO THERMAL RUNAWAY
3. FAST SWITCHING FOR HIGH EFFICIENCY
4. EXCEEDS MIL-STD-19500
5. CASE: JEDEC DO-41, MOLDED CASE
6. DIMENSIONS IN INCHES AND (MILLIMETERS)
7. POLARITY: INDICATED BY CATHODE BAND
8. WEIGHT : 0.2 GRAMS
9. TERMINALS : PER MIL-STD-202, METHOD 208
10. PULLING TEST: 2.3 KG
11. ROHS

MAXIMUM RATINGS AND ELECTRICAL CHARACTERISTICS RATINGS AT 25°C AMBIENT TEMPERATURE UNLESS OTHERWISE SPECIFIED STORAGE AND OPERATING TEMPERATURE RANGE -55°C TO + 150°C. SINGLE PHASE, HALF WAVE, 60 HZ, RESISTIVE OR INDUCTIVE LOAD. FOR CAPACITIVE LOAD, DERATE CURRENT BY 20%

RATINGS	SYMBOL	VALUE	UNITS
MAXIMUM AVERAGE FORWARD RECTIFIED CURRENT 0.375"(9.5mm) LEAD LENGTH @ 55°C	IO	1	A
PEAK FWD SURGE CURRENT, 8.3ms HALF SINE-WAVE SUPERIMPOSED ON RATED LOAD	IFSM	30	A
TYPICAL JUNCTION CAPACITANCE(NOTE 1)	CJ	15	pF
TYPICAL THERMAL RESISTANCE (NOTE 2)	Rqja	50	°C/W
MAXIMUM FORWARD VOLTAGE	VF	1.2	V
MAXIMUM REVERSE CURRENT @ 25°C	IR	5	uA
MAXIMUM REVERSE CURRENT @ 100°C	IR	50	uA
MAXIMUM REVERSE RECOVERY TIME	TRR	120	nS

1. MEASURED @ 1 MHZ AND APPLIED REVERSE VOLTAGE OF 4.0 VOLTS
2. BOTH LEADS ATTACHED TO HEAT SINK 20x20x1t (mm) COPPER PLATE @ LEAD LENGTH 5mm
3. MAXIMUM FORWARD VOLTAGE AT IO DC

PART NUMBER	MAX RECURRENT PK REV VOLTAGE VRRM (V)	MAX RMS VOLTAGE VRMS (V)	MAX DC BLOCKING VOLTAGE VDC (V)
1N4933S	50	35	50
1N4934S	100	70	100
1N4935S	200	140	200
1N4936S	400	280	400
1N4937S	600	420	600

RATING AND CHARACTERISTIC CURVES

FIG. 1-TEST CIRCUIT DIAGRAM AND REVERSE RECOVERY TIME CHARACTERISTIC

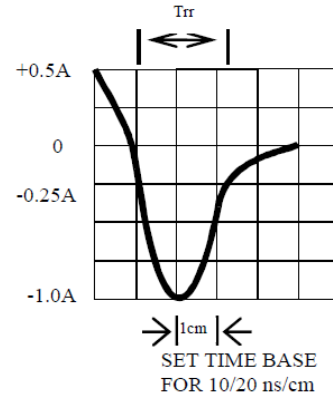
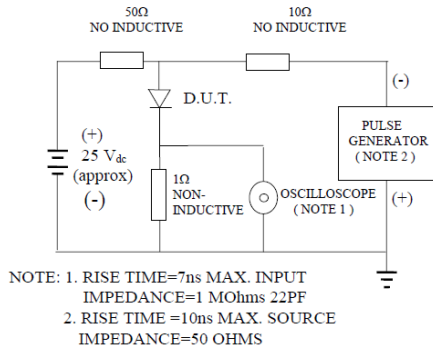

Fig. 2-MAXIMUM CURRENT DERATING CURVE

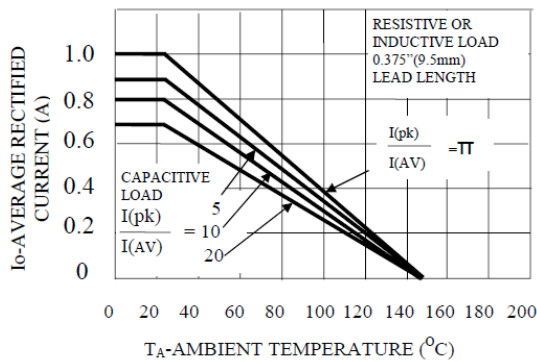

FIG. 3-TYPICAL JUNCTION CAPACITANCE

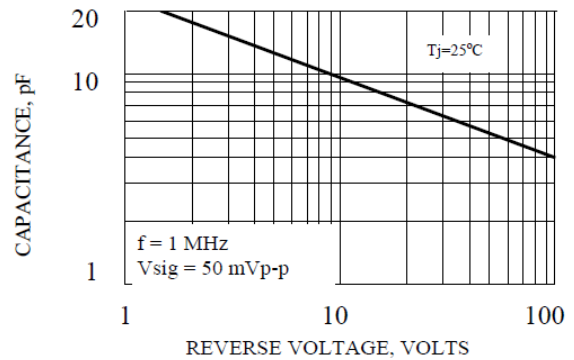

FIG. 4-TYPICAL REVERSE CHARACTERISTICS

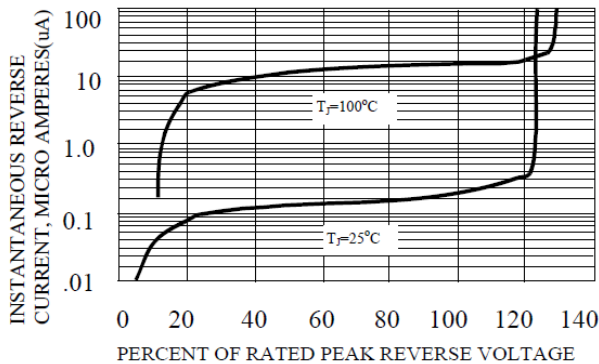
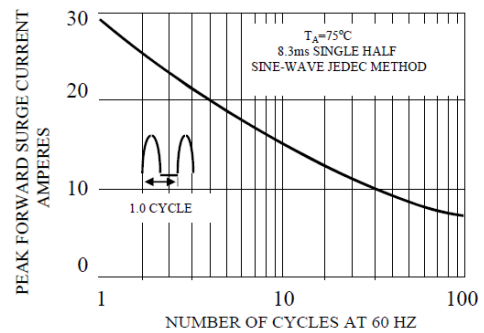

Fig. 5-MAXIMUM FORWARD SURGE NUMBER OF CYCLES





1N4933S THRU 1N4937S SPECIFICATIONS

Rev. A

